

WHEEL BALANCER

USER MANUAL

B00EN

Pls read this manual before operation

CONTENT

1. Preface	1
WARNING CLAUSE	1
INTRODUCTION	1
INSTALLATION	1
SAFETY REGULATION	2
2. INSTALLATION & OPERATION	4
2.1INSTALLATION OF THE PROTECTIVE COVER	4
2.2INSTALLATION OF THE MAINSHAFT	4
2.3EQUIPPING POWER SOURCE	4
3. TECHNICAL PERFORMANCE	4
3.1PERFORMANCE & CHARACTERISTICS	4
3.2MAIN TECHNICAL SPECIFICATION	5
3.3WORKING PRINCIPLE	5
4. TRANSPORTATION & INSTALLATION	5
4.1TRANSPORTATION	5
4.2INSTALLATION	6
5. SAFETY PRECAUTIONS	6
6. CONFIGURATION & USE	7
6.1 CONFIGURATION	7
6.2 CONTROL PANEL	8
6.3 BASIC OPERATION	8
6.4 VALUE INPUT	9
6.5 RESIDUAL UNBALANCE VALUE DISPLAY	10
6.6 BALANCE MODE & ALU BALANCE MODE SELECT	11
6.7 SUPPLEMENTARY EXPLANATION	12

7. PROGRAM SETUP	12
7.1 PROGRAM FUNCTION INTRODUCTION	12
7.2 ERROR	13
7.3 PRESSURE SENSOR INSTALLATION & WIRING	14
7.4 GENERAL TROUBLESHOOTING & SOLUTION	14
7.5 ACCESSORIES	15
8. MAINTENANCE	18
9. OPERATION DETAILED DESCRIPTION	20
9.1 HOW TO BALANCE A WHEEL	20
9.2 PARAMETER SETUP	21
9.3 CUSTOMER SELF-CALIBRATION	22
APPENDIX 1	
APPENDIX 2	

1.PREFACE

WARNING

There will be one year of warranty period on the condition that the machine including the operation system , tools and accessories are used properly and/or without damage. During this period, the manufacturer will repair or replace the parts returned or the machine itself, sustaining the costs but not accepting responsibility for normal wear and tear, incorrect use or transportation, or failure to carry out maintenance. The manufacturer will not inform the customer about any improvements to the products or the upgrading of the production line.

INTRODUCTION

The purpose of this manual is to provide the owner and operator of this machine with a set of safe and practical instructions for the use and maintenance of the wheel balancer.

If such instructions are carefully followed, the machine will offer you the levels of efficiency and duration.

The following paragraphs define the levels of danger regarding the machine.



DANGER: Refers to immediate danger with the risk of serious injury or death.



WARNING: Dangers or unsafe procedures that can cause serious injury or death.



ATTENTION: Dangers or unsafe procedures that can cause minor injuries or damage to property.

Read these instructions carefully before using the machine. Keep this manual and the illustrated materials supplied with the equipment in a folder near the place of operation so as to allow the machine operators to consult the documentation at any time.

The manual is only to be considered valid for the machine serial number and model stated on the attached nameplate.

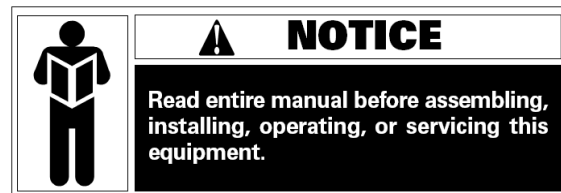

The instructions and information described in this manual must always be complied with: the operator will be held responsible for any operation not specially described and authorized in this manual.

Some of the illustrations contained in this booklet have been taken from pictures of prototypes: standard production machines may differ slightly in certain respects. These instructions are for the attention of personnel with basic mechanical skills. We have therefore condensed the descriptions of each operation by omitting detailed instructions regarding, for example, how to loosen or tighten the fixing devices. Do not attempt to perform operations unless properly qualified or with suitable experience. If necessary, please contact an authorized Service Centre for assistance.

INSTALLATION



Take the utmost care when unpacking, assembling, lifting and setting up the machine as indicated below.

Failure to observe these instructions can damage the machine and compromise the operator's safety.

Remove the original packing materials after positioning them as indicated on the packaging.



All regulations in force concerning safety at work must be complied with when choosing the installation position.

In particular, the machine must only be installed and operated in protected environments where there is no risk of exposure to dripping.

IMPORTANT: for the correct and safe operation of the machine, the lighting level in the place of use should be at least 300 lux.

Environmental operating conditions must comply with the following requirements:

- relative humidity ranging from 30% to 80% (without condensation);
- temperatures ranging from 0° to +50°C.



The floor must be strong enough to support a load equal to the weight of the equipment plus the maximum load allowed.



The machine must not be operated in potentially explosive atmospheres.

SAFETY REGULATIONS



Failure to comply with the instructions and danger

warnings can cause serious injuries to the operator or other persons.

Do not operate the machine until you have read and understood all the danger/warning notices in this manual.

The correct use of this machine requires a qualified and authorized operator. This operator must be able to understand the manufacturer's written instructions, be suitably trained and be familiar with the safety procedures and regulations. Operators are forbidden to use the machine under the influence of alcohol or drugs that could affect his/her physical and mental capacity.

The following conditions are essential:

- read and understand the information and instructions described in this manual;
- have a thorough knowledge of the features and characteristics of the machine;
- keep unauthorized persons well clear of the working area;
- make sure that the machine has been installed in compliance with all relevant standards and regulations in force;
- make sure that all machine operators are suitably trained, that they are capable of using the machine correctly and safely and that they are adequately supervised during work;
- do not touch power lines or the inside of electric motors or any other electrical equipment before making sure that they have been powered off;
- read this booklet carefully and learn how to use the machine correctly and safely;
- always keep this user manual in a place where it can be readily consulted and do not fail to refer to it.



Do not remove or deface the DANGER, CAUTION, WARNING or INSTRUCTION decals. Replace any missing or illegible decals. If any decals have become detached or damaged, it is possible to obtain them from your nearest reseller.

-Observe the unified industrial accident prevention regulations relating to high voltages and rotating machinery whenever the machine is in use or being

serviced.

- Any unauthorized changes or modifications made to the machine automatically release the manufacturer from any liability in the case of damage or accidents resulting from such changes or modifications .



WEAR PROTECTIVE GLOVE



READ OPERATION MANUAL



WEAR PROTECTIVE GLASSES



POWER OFF THE ELECTRICAL SOURCE OF THE MACHINE DURING MAINTANCE

Meaning of the decals(including the one indicating caution)

Lightning symbol: This decal, positioned on the back of the machine, indicates where to insert the power supply cable and warns the user to pay attention to his safety.



Warning for rotating machine part

This decal, positioned next to the balancing shaft, reminds the user that this is a rotating part and is therefore dangerous and should not be touched with the hands. The arrow indicates the rotation direction.



Grounding symbol: This decal, positioned on the rear left side of the machine,

indicates where to connect the ground wire.

DECAL LOCATION DIAGRAM

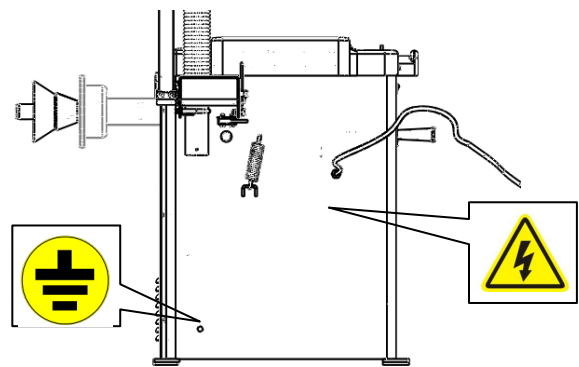

Nameplate

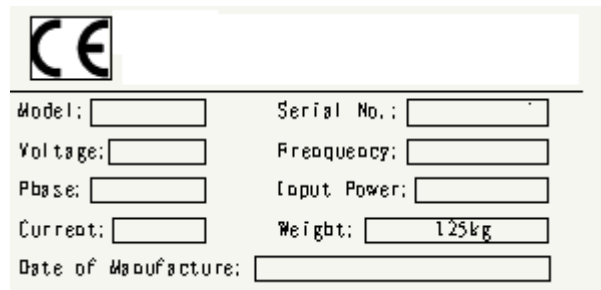

Note: The following information coming from the nameplate

The nameplate is stuck in the center to the top on the rear of the machine. The meaning of each part is in the following:

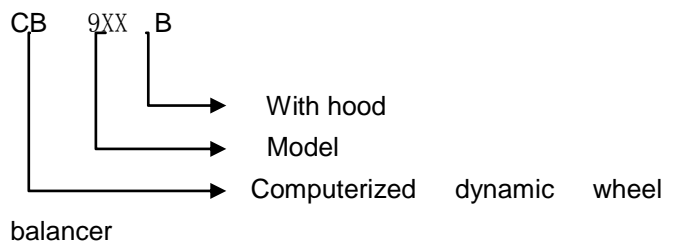

B. CE certificate



This mark indicates that this model of machine has got the CE certificate

C. Series No The first 3 numbers is the abbreviate of the model. The middle 4 is the manufacture date and the last 4 is company product series number.

D. What on the cross line is the name and address of the company and under the cross line not includes the above explained but the rated electrical parameters,

such as voltage, frequency, power, phase number & full load current, and the weight and manufacture date of the machine.

If the B has noted in the model of the machine, it means the machine with the protection cover. It means without the equipment of the protection cover if without the note of B.

2 INSTALLATION AND OPERATION

Before installation and use of the wheel balancer, you should carefully read this installation and operation manual. And keep this manual in hand for reference at any time. You should be sure that all the operators have read this manual to guarantee the most perfect functions of the machine and meanwhile the safety.

2.1 PROTECTIVE HOOD INSTALLATION:

: shown in page 26~27

2.2 MAIN SHAFT INSTALLATION

MAINSHAFT INSTALLATION: Before installation, use the ethyl alcohol and compressed air to clean up the center hole of the shaft and connect part. Use spanner and screw to fix the thread shaft on the balance shaft (Fig2)

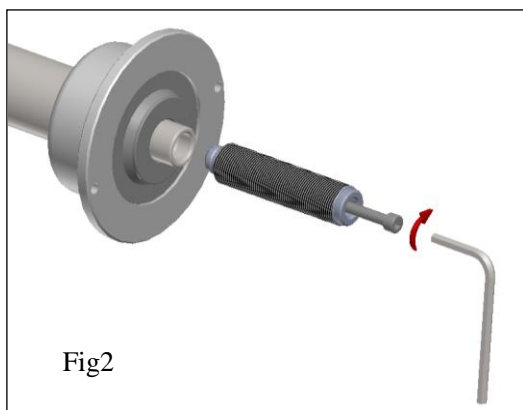

2.3 ELECTRICAL CONNECTION & EARTHING

According to the label on the connect between power cable and body, the power cable connect socket must be grounded with the reliable earth wire.

All the electrical devices installation must be done by the qualified staff. Before installation, please check If the power system is comply with the technical

parameter marked on the nameplate of the machine. The wiring of the machine must have the fuse and the perfect ground protection. And install the electrical Leakage automatic controls switch in the power source. And recommend the application of the stabilizer if the voltage of installation site is unstable.



Any electrical connect in the workshop is only done by the qualified technical staffs and it should meet the enforced regulation.

Any electrical connect must be according to the following:

- Power on the data plate on the machine;
- Voltage decrease can not exceed 4% of the rated voltage on the data plate when full load (10% when start)
- Operators must:
 - Install the plug;
 - install 30ma circuit breaker;
 - install power cable fuse;
 - provide with effective workshop electrical connect to ground;
- prevent the authorized operation and pull out the plug to prolong the working life when not use the machine.
- if the machine directly connected to the power source through the power board not the plug, we should use the qualified staffs to operate.



Perfect ground is necessary for the correct operation. Do not connect the machine with air pipe, water pipe, telephone line and the other unsuitable objects

3 . TECHNICAL FEATURES

3.1 FEATURES:

- adopts quality computer with the feature of high intelligence and high stable
- mechanical main shaft adopts high precision bearing

driven, wear-resistant, low noise

- press stop key to realize the emergency stop
- full automatic dynamic/static balance check
- balance 3 ALU rim and 1 motorcycle tire
- self-calibration and full automatic trouble diagnosis

3.2 MAIN TECHNICAL SPECIFICATION

- rated voltage 220V/110V (selectable) 50/60HZ、380V/50HZ/1P
- power 250W
- speed 7S (if the weight of the wheel is about 20Kg)
- accuracy $\pm 1g$
- noise $\leq 69dB$
- rim diameter 10"~24"
- maximum wheel weight 65kg
- rim width 1.5~20"
- max wheel diameter 44inch

Special instruction:

For the outreach of the main shaft is limited, so there is some limit to the distance from flange disk to the outside edge of the tire should less than 170mm as shown in the figure. On this condition, you can operate correctly.

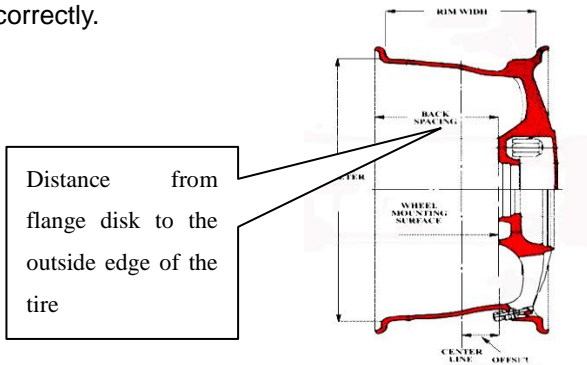

3. 3Work principal

Balancing sensor tests the unbalance signal and send it to the terminal of the microprocessor via A/D converter. Processor will calculate the unbalance value through synthesized analysis to the unbalance signal and angle signal of the main shaft.

4. INSTALLATION & TRANSPORTATION

4.1 TRANSPORTATION

- Place, carry and store the machine according to the indication of the label on the package carton.
- Store environment: RH20%-95% temperature -10°C-+60°C
- When transport and use the machine, do not pull the rotation shaft, or it will cause the permanent damage



Do not lift the machine at any other position.

4. 1. 1After being sure that the package of your machine is perfect, you can carry the wheel balancer to the installation site.(Fig3). The choice of the installation should comply with the following requirements. The ambient temperature is 0°C-50°C and the RH $\leq 85\%$. And the installation site as shown in Fig4

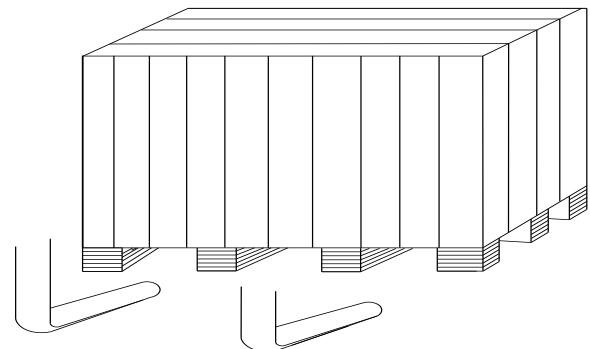
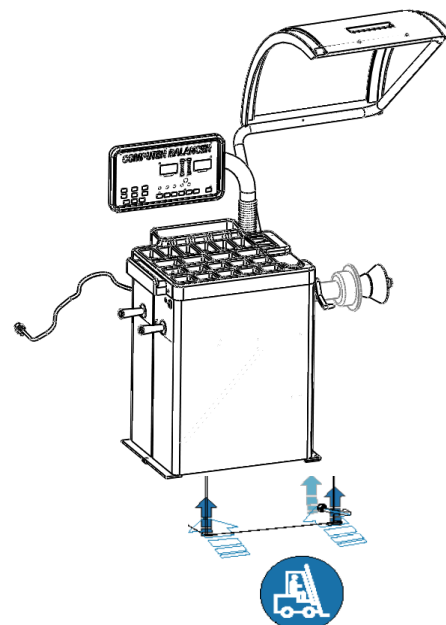

FIG3



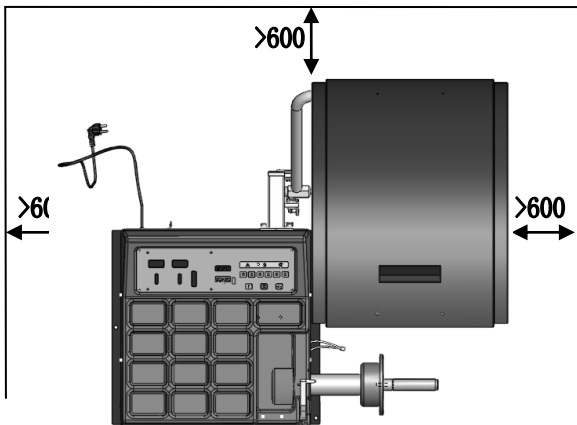
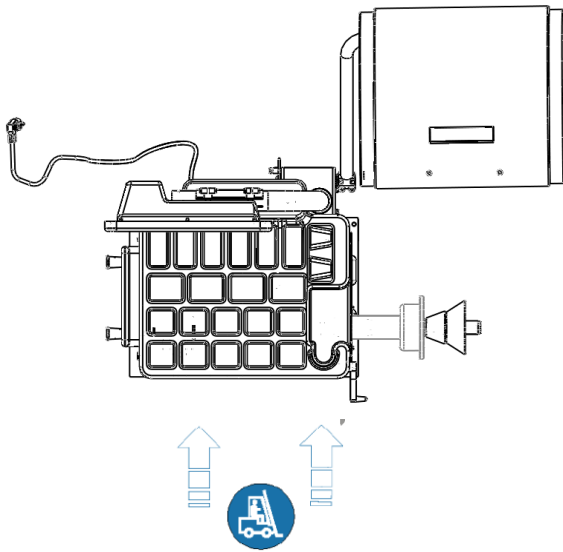

Fig 4

4.1.2 Remove the upper cover of the package carton and check and confirm the wheel balancer, spare parts and documents you purchased according to the packing list. If you have any question, please contact with the dealer.

Package materials such as plastic, PBV, nail, screw, timber and carton must be placed into a scrap bin to treat according to the local regulation.

4.2 INSTALLATION

Remove the connect bolt. And carry down the wheel balancer to place it on the flat and solid floor. We should store it indoor to avoid it from being exposed to

the sunlight for long time and the moisture.

5.SAFETY AND PREVENTION

5.1.1 Before operation, please confirm that you have read the entire warning label and the instruction manual. Not according with the safety instruction can cause the injuries to the operators & bystanders.

5.1.2 Keep your hands and the other parts of your body from the location with the potential danger. Before starting the machine, you must check it there existing the damaged part. If any break or damage, the machine will not be used.

5.1.3 In emergency situation, if the tire not fixed, you should press "STOP" to stop the rotation of the wheels. Adopts high strength protective cover to prevent the tire from flying in any direction and can only fall on the ground to protect the safety of the operators.

5.1.4 Before balancing, operators should check all the tires and wheels to find the possible faults. Do not balance the tires and wheels with fault.

5.1.5 Do not exceed the load capability of the wheel balancer and do not attempt to balance the wheel bigger than the designed dimension.

5.1.6 Wear suitable clothing such as suitable safety suit such as glove, glasses and working suit. Not wear necktie, long hair, loose clothing. The operators should stand beside the machine when operation the machine. Keep from the unauthorized personnel.

5.1.7 Before balancing, you must confirm the installation of the wheel suitable. Before rotation, be sure the nut turn 4turns around the thread shaft and firmly locked on the main shaft.

GENERAL CONDITIONS OF USE



The wheel balancers described in this manual must be used exclusively to measure the extent and position of car wheel unbalances, within the limits specified in the technical data section. Furthermore, models equipped with motors must be provided with a suitable guard.



Any use other than those described in this manual is to be considered improper and unreasonable.



Do not start the machine without the wheel locking equipment.



Protective hood plays the role of prevention and safety.



Do not clean or wash the wheels mounted on the machine with compressed air or jets of water.

Get to know your machine. The best way to prevent accidents and obtain top performance from the machine is to ensure that all operators know how the machine works.



Learn the function and location of all the controls.



Carefully check that all controls on the machine are working properly.



The machine must be installed properly, operated correctly and serviced regularly in order to prevent accidents and injuries.

6. CONFIGURATION & USE

6.1 CONFIGURATION

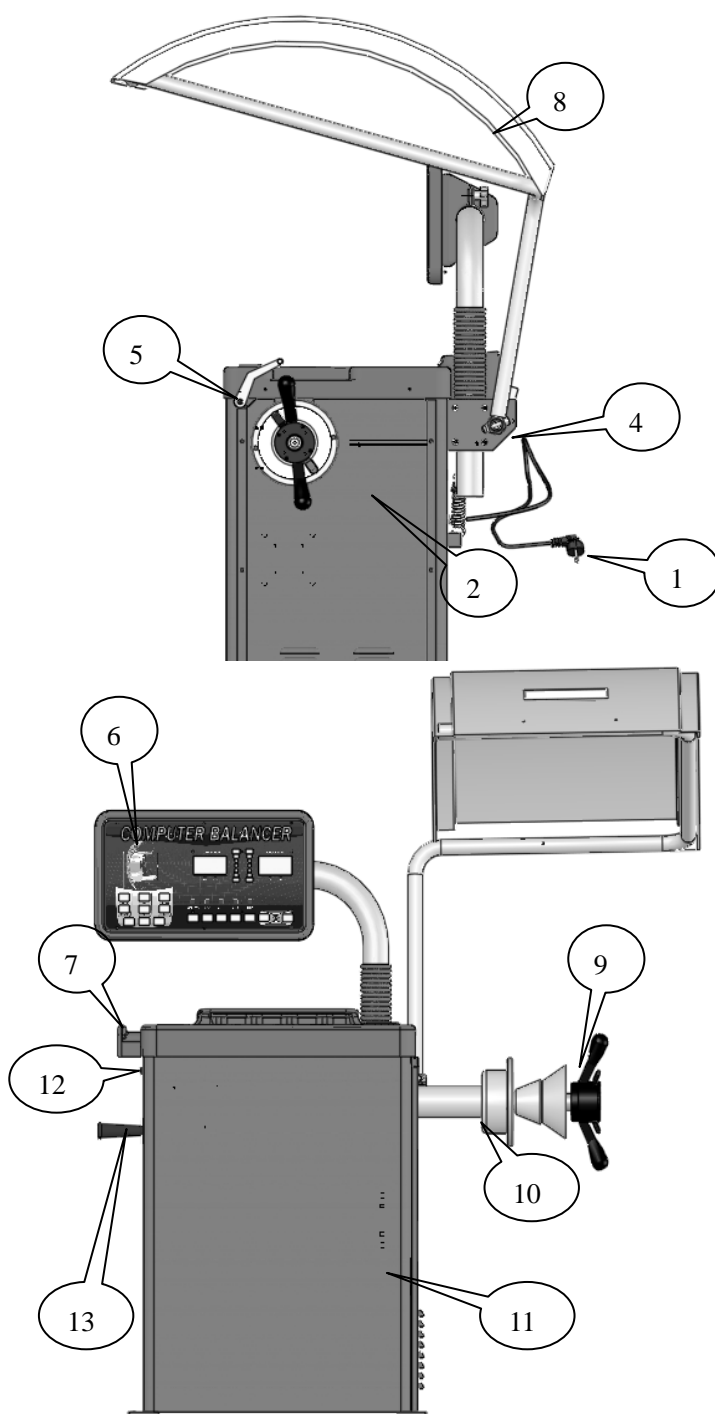
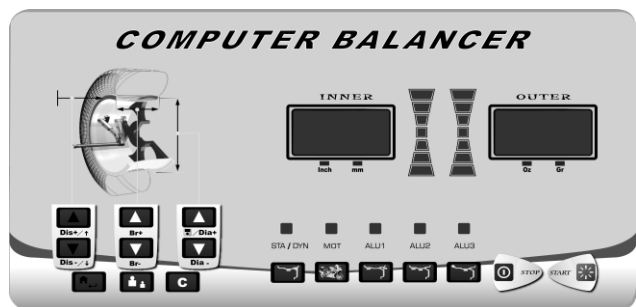

Fig 5

- 1- power & plug
- 2- Side Panel
- 3- Return Spring
- 4- main switch
- 5- Scale
- 6- control panel
- 7- Weight Tray
- 8- Hood
- 9- Quick Nut
- 10- Balance Shaft
- 11- body
- 12- power switch
- 13. Cone Storage Handle

6.2 DISPLAY PANEL & CONTROL PANEL



Dis+ / ↑



Dis- / ↓

1. In the state of parameter input, it is the distance from wheel to balancer input key .You can change the Br set value of the window by press the up/down key.



Br+



Br-

2. Br value input key You can change the Br set value of the window by press the up/down key.



Dia -

3. In the state of parameter input, it is the diameter of the rim input key. You can change the D set value of the window by press the up/down key.



4. High accuracy balance key: When the display displays [00], press this key the display will display the unbalance value less than 5g.



5. Unit conversion key can convert the unit of the unbalance value and size.



6. Balancing mode selection key.



7. Function key & confirm key



8. Emergency stop key



9. Start key

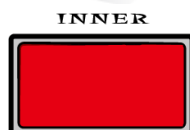

10. Inner unbalance value and parameter of the tire display



11. Outside unbalance value and tire parameter display

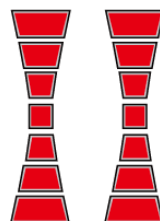

12. Unbalance position lamp.



STA / DYN



MOT



ALU1



ALU2



ALU3

13. Balancing modes display lamp

6.3 BASIC OPERATION

6.3.1 Switch on the main switch on the left side of the machine, the display will display [000]-[700] → [UER]-[2.140] and then [0]-[0] (it will display [0.00]-[0.00] in ounce state)

6.3.2 MOUNT WHEEL

Preparation before test: Check and clean the dust and mud and if there are foreign bodies, such as metal and stone, clipped on the surface of the tire. And also check the air pressure of the tire is according with the specified value. Check if there are deformation on the rim positioning surface and installation hole. Check if there are any foreign bodies in the tire. Take off the original weight.

The installation methods of the wheel : Positive positioning, negative positioning & flange disk when handling the middle and big sizes of tires. You can select the methods according to the different conditions.

6.3.2.1 SMALL CAR WHEEL POSITIVE POSITION

Positive positioning is the normal method. It is featured with simple and quick operation. It is mainly suitable to the common steel rim and aluminum alloy rim with small deformation.

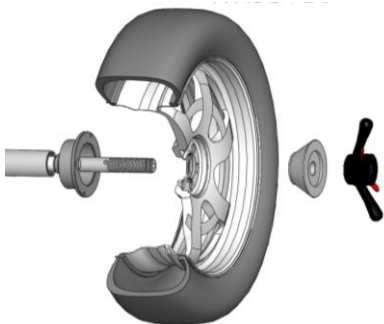

Main shaft → wheel (direction of the rim installation surface is inside) → cone → quick nut

6.3.2.2

When the deformation of the outside of the wheel, adopt this method to positioning to grantee the accurate positioning of the steel rim inner hole and main shaft. It is suitable to the steel rim, especially the thick ALU



Main shaft → lower spring → suitable cone wheel → bowl → quick nut

6.3.2.3 FLANGE DISK POSITIONING (OPTIONAL)

Suitable to the big tire assemble

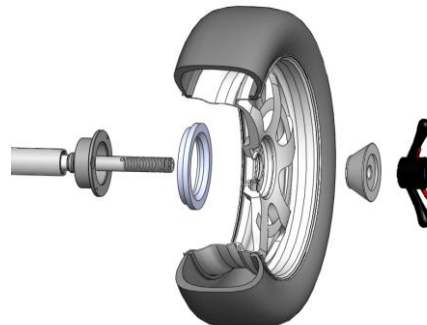

Main shaft → flange disk (fixed on the main shaft) wheel → cone → quick nut

NOTE: The choice on the cone should be adapted to the rim center hole and pay attention to its direction. Or it will cause the inaccurate measurement.

6.4 INPUT VALUE

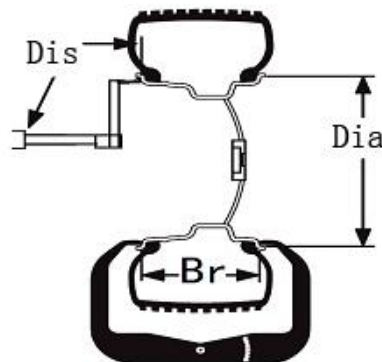

6.4.1 Input DIS (Distance)

Pull the scale to the inner position to add the weight





and press the key to input the DI value into the display. At this moment, the display will

display [DIS]: XXXX, And the default system is mm.



6.4.2 Input Br (RIM Breadth) Value

Use the Br measurement caliper to measure the Br of

the rim, press the key   to input the Br value into the display. At this moment, the display will display [BR]: XXXX. And the default system is inch.

6.4.3 Input the DiA(Diameter)Tire Diameter Value

After confirming the rim diameter, press the key

  to input the rim diameter into the display. At this moment, the display will display [DIA]: XXXX. And the default system is mm.

6.4.4 UNIT CONVERSION:



①The unit conversion of the Br of the rim from inch to mm:

Normally, the display of Br should be in inch. When you need the unit of the display to be mm, you can use the

 key to realize the unit conversion from inch to mm.

②The unit conversion of the DIA of the rim from inch to mm:

Normally, the display of D should be in inch. When you need the unit of the display to be mm, you can use the

key  to realize the unit conversion from inch to mm.

After unit conversion, the unit of the display values of rim Br and D are , but when you switch off and then on the wheel balancer, the unit will be still inch.





③The unit conversion from gram to ounce: Normally, the unit of the unbalance value is gram (g). If you want to make the ounce(Oz) to be the unit, you can execute the g/Oz conversion. The unit of the displayed unbalance value is gram(g). The way to realize the unit

conversion from gram to ounce is to press 

6.4.5 When press the start key, the wheel balancer starts to run. A few seconds later, the machine automatically stops. The machine can also start by

lowering down the protective hood which can be set by the program.

6.4.6 DISPLAY UNBALANCE VALUE

When the spin ends, the display will display the inner  and outer  unbalance value of the rim. Use your hand to pull the wheel. When all the positioning lamps light inside and outside light, the weight adding position will be indicated.

6.4.7 Rotate the wheel, when the left side positioning lamp all light, at this moment, the highest position is the inner unbalance position and when the right side positioning lamp all light, at this moment, the highest position is the outer unbalance position.

6.4.8 Add the corresponding weight at the unbalance point and start test again until the balance of the tire.

Attention:



1. When start the machine, use hand to pull the wheel to help it start rotation, especially to the relative bigger tire, to prolong the working life of the motor.
2. Check if there are any mistakes on the dimension. Check if the balance methods meet the configuration of the rim and select the balancer most easily to balance.
3. Check if the quick lock nut tight or not.
4. When the balance ends, remove the tire. Pay attention to handle it with gentle and avoid knocking the main shaft.
5. When clipping the weight. Use the hammer to clip the weight on the rim without too much force. Do not knock the main shaft hardly to avoid damaging the sensor. The position to add the Weight should be free from the grease and should be dry.

6.5 RESIDUAL UNBALANCE VALUE DISPLAY

The minimum value of the standard weight is 5g so if the weight you use is less than 5 g, the wheel balancer will not display the value and only displays the state of

“00”. When you need to display the residual unbalance value, you should press  and the display will immediately display the inside or outside unbalance value of less than 5g. The maximum residual unbalance value is 4 g.

6.6 BALANCE MODE SELECT

Press the corresponding  key to choose the balance mode. If all the lights not light up, it is the dynamic mode.

 **DYNAMIC**—clip the weight on both sides of rim (dynamic balance test once start)

 **STATIC**— Stick the weight in centre

 **MOT**—optional for balancing the motorcycle

When balancing motorcycle wheels, you require the (optional) motorcycle adaptor accessory MJ-II. With the assistance of the extension scale to measure Di, Br and Di. Input the measure value into the Di, Br and Di display window. The input method is similar to the parameter input of the car.

 **ALU1**— to balance the light aluminum alloy rim. Adopt clip the weight on the shoulders of the rim

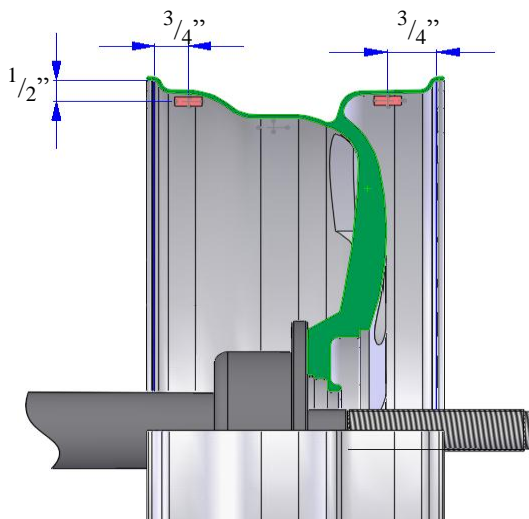

ALU1

$$Dis1 = Dis + 3/4''$$

$$Dis2 = Dis + Br - 3/4''$$

$$Dia1 = Dia - 1''$$

$$Dia2 = Dia - 1''$$

ALU2— for ALU rim, hidden weight inside

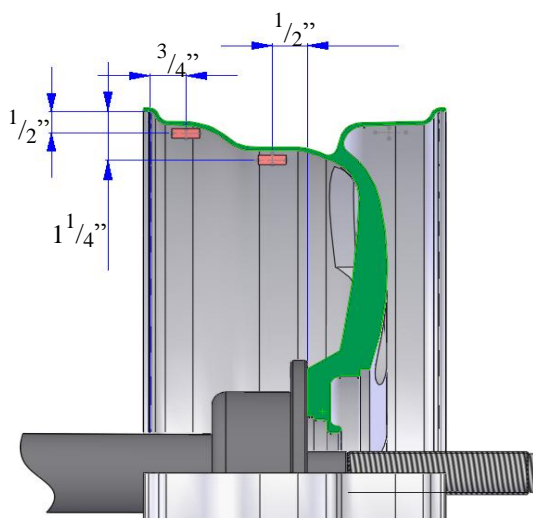

ALU2

$$Dis1 = Dis + 3/4''$$

Dis2= from 0 point to the outer of the flange disk -1/2''

$$Dia1 = Dia - 1''$$

$$Dia2 = Dia - 2 1/2''$$



ALU3—clip the weight inside and the position to add weight outside is same to ALU2.

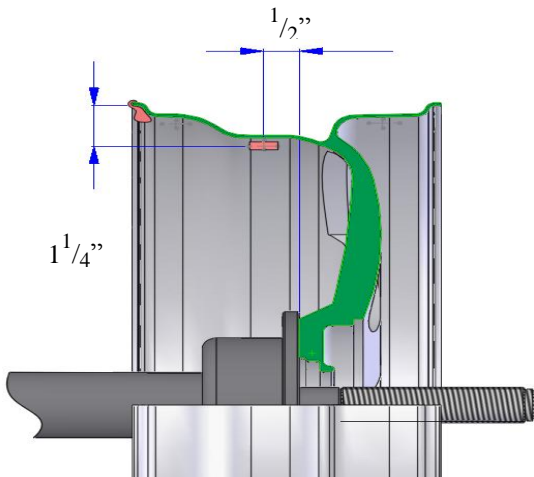

ALU3

Dis1=Dis

Dis2= from 0 point to the outer of the flange disk—

$1/2$ "

Dial=Dia

$Dia2=Dia-2 \frac{1}{2}$ "

6.7 SUPPLEMENTARY EXPLANATION:



Once switching on, you will see standard dynamic balance mode setup by the computer. When selecting ALU mode and the configuration of the aluminum alloy rim is similar to the above standard ALU1\ALU2\ALU3, you can get relative accurate balance effect. If the section of the tire similar to the one given be the program, you need do some adjustment on the position and weight of the weight. General speaking, 1~2 times of adjustment can reach relative satisfactory balance effect.

7 PROGRAM SETUP

7.1 PROGRAM FUNCTION INTRODUCTION



Press program  key to enter the program setup menu.

-p- (protective cover setup) and then press  key

to confirm the entrance. Select   to set the on/off of the protective cover function. Then press

 key to return to the upper level.

SP (protective cover control function setup) Select

  to enter. And press  key to enter. The setup is same to the above.

APP(Balance unit setup) can setup 1Gr and 5Gr. The setup is same to the above.

BIP (beeper setup) can setup the on/off of the beeper. The setup is same to the above.

SET UP Press  to enter the special function setup.

IN TES (sensor test) to test the photocell and STA/DYN sensor.

Next menu: Select   to enter $\{CAL\}$ $\{-CAL\}$.

This function is used when the machine has not been used for long time or the balancing is not accurate.

Self-calibration program setup: Press  to enter

into the program and then press  to Confirm and the display will display ADD -0. Press the start key to start the test. After running, the display will display ADD -100, rotate the tire until all of the unbalance position lamp light up. Clip a weight of 100g at the 12 clock position on the tire. Once again start the machine to realize the self-calibration of the machine. Enter the shortcut method of the self-calibration program and

hold on pressing  for 5seconds and enter "ADD"-0".

The above operation step vector diagram is as follows:

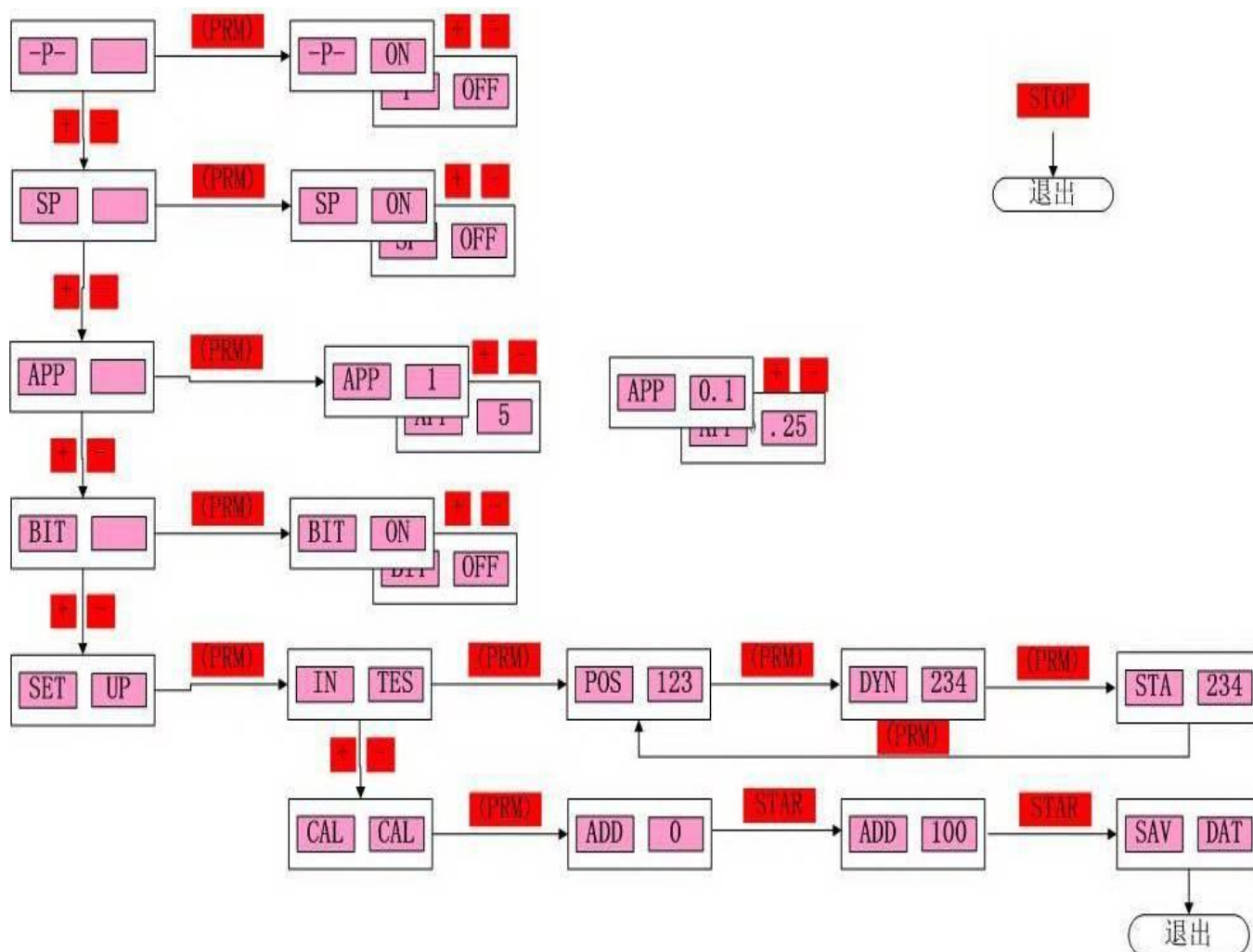

If you can not solve by the above mentioned method, pls contact with the professional persons.

7.2 ERROR INDICATION

DISPLAY	CAUSE	SOLUTION
ERR OPN	protective cover not lower down	Lower down the protective cover
ERR SP	rotation speed not enough photocell coupler cannot collect signal	Check the motor and belt. Check if the display of the photocell data normal
ERR OFF	error of stop	Press the start key or rise up the protective cover.
ERR FAC	factory set-up fault	Correct factory set-up
ERR USR	customer set-up fault	Customer set-up
ERR	Reverse rotates is	Troubleshooting of

REU	not correct	power board Check power cable connection correct or not, the wire sequence of the 3-phase motor must be correct
-----	-------------	--

If cannot solve as per the above methods, please contact the professional personnel

7.3 PRESS SENSOR INSTALLATION AND WIRING

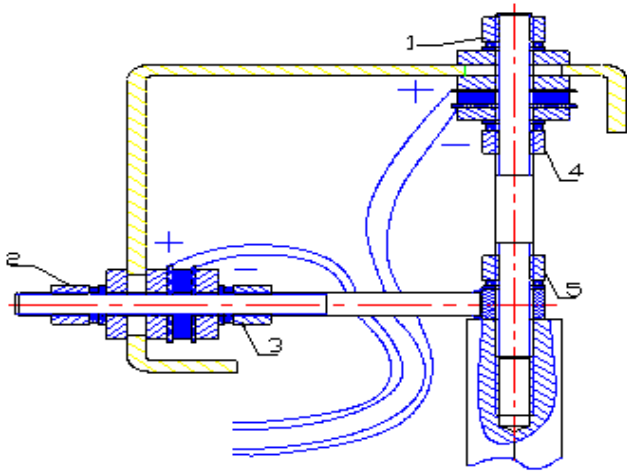

Sometime, the troublesome of inaccuracy of balancing and position if because the damage of the press sensor. The method to change the press sensor is shown in the following:

- Demount the upper cover and right side panel of the wheel balancer.
- Remove the nut 1&2, elastic washer, sanding washer and plain washer.
- Loose the nut 3, 4 and 5 to disassemble each part.
- Change the new sensor and mount the double head screw and tight the nut 5.
- Use the spanner to tight nut 4 slightly and then tight nut 3. At this time, pay attention that the horizontal and vertical sensor screw should to perpendicular to each other. The end of the screw should fall into the center of the hole with the gap of at least 1mm.
- Mount the plain washer, sanding washer, elastic washer and nut 1 and 2. It must be completely tight. Generally speaking, you should fix the nut 1 first and then nut 2.)
- There is the glass glue protective coating on the pressure sensor.

- Short cut connect of press sensor output cable to discharge and then plug the cable discharged into the computer board to avoid the high voltage to break down the computer board.
- Plug the sensor plug according to the original position.
- Calibrate the balancer once again and mount the upper cover and side panel.

After change the computer board, phase sensor or the press sensor, you must execute the self-calibration. In the process to change the computer board, you should setup the parameter according to the parameter marked in the machine or the original board. You must self-calibrate after changing











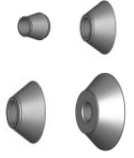



7.4 GENERAL TROUBLESHOOTING & SOLUTION: :

Description	Cause	Solution
Start the machine but not display.	<ol style="list-style-type: none"> 1. Check the circuit of 220V is normal or not. 2. power board fault 3. The cable between the power board and computer loose 4. computer board fault 	<ol style="list-style-type: none"> 1. Check and connect the external power source. 2. Changer the power board 3. Check the plug cable 4. Change the computer board
Display is normal but the start button and input push button not working.	<ol style="list-style-type: none"> 1. contact switch not good 2. machine breakdown 	<ol style="list-style-type: none"> 1. Open the housing of the machine and plug in and tight the contact switch plug. 2. Start the machine again
Display is normal but not braking after start.	<ol style="list-style-type: none"> 1. The cable between the power board and computer loose 2. power board fault 2. Brake resistor damage 	<ol style="list-style-type: none"> 1. Plug in and tight the cable between the computer board and power board. 2. Change the power board 3. Change the

	3. computer board fault	computer board
Balance is not accurate & difficult to reach "00"	1. sensor lead connect or contact no good 2. memory value lost	1. Connect again 2. Correct the memory value according to the manual.
Each spin, the change of the value will not exceed 5g	1. There are foreign body on the rim or the assemble surface in the rim center deformation 2. sensor damp or quick nut not tightly clamped 3. The external power voltage or the air pressure not enough. The flange dick not locked.	1. Change the wheel 2. Oven, recalibrate the sensor. 3. Fix the anchor bolt.
Each spin, the range of the change of value will be 20-90g.	1. There are foreign bodies on the wheel or the unbalance of the wheel value too big. 2. sensor damage 3. external power source voltage too low	1. Change the wheel 2. Check the sensor and wiring. 3. Check power source and assemble stabilizer.
Balance is not accurate & difficult to reach "00"	1. Sensor damp or damage 2. Program chore	1. Calibrate again, oven and then self-calibration or change 2. Self-calibration again
When second mount & demount, the error will	1. Wheel internal hole irregular 2. Flange disk assemble not properly	1. Change the wheel 2. Check the assemble surface

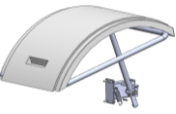
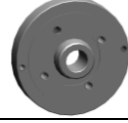
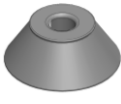
exceed 10g.		and try again.
-------------	--	----------------

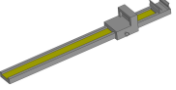
7.5 Wheel balancer standard accessory

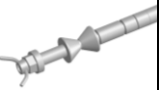
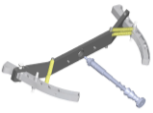
STANDARD ACCESSORY					
ACCESSORY	DESCRIPTION	QUANTITY	ACCESSORY	DESCRIPTION	QUANTITY
	CONE	1 SET		BR SCALER	1 PIECE
	PLIER	1 PIECE		THREAD SHAFT	1 PIECE
	QUICK NUT	1 PIECE		WEIGHT	1 PIECE
	SPRING	1 PIECE		BOWL EDGE	1 PIECE
	BOWL	1 PIECE		HEXA BOLT M10X160	1 PIECE
OPTIONAL ACCESSORY					
ACCESSORY	DESCRIPTION	ACCESSORY	DESCRIPTION	ACCESSORY	DESCRIPTION
	HOOD		4-POSITION ADAPTOR		
	LARGE CONE		FLANGE DISK		
	WEIGHT STICK SCALE		CENTERLESS RIM CALIP		
	DK-W-1		MJ-I		
	MJ-II				

8. MAINTENANCE



WARNING

The manufacturer will not bear any responsibility in the event of claims resulting from the use of non-original spare parts or accessories.



WARNING

Unplug the machine from the socket and make sure that all moving parts have been locked before performing any adjustment or maintenance operation.



WARNING

Do not remove or modify any part of the machine (except for service interventions).



CAUTION

Keep the work area clean.
Never use compressed air and/or jets of water to remove dirt or residues from the machine. Take all possible measures to prevent dust from building up or rising during cleaning operations. Keep the wheel balancer shaft, the securing ring nut, the centering cones and flange clean. These components can be cleaned using a brush previously dipped in environmentally friendly solvents. Handle cones and flanges carefully so as to avoid accidental dropping and subsequent damage that would affect centering accuracy.

Type of thickener	Li-complex
Colour, appearance	Dark blue
Penetration on the processed item 25°, ASTM D 217, mm/10	235
Dropping point, °C, ASTM D 2265	280
Viscosity oil base, ASTM D 445,	100

After use, store cones and flanges in a place where they are suitably protected from dust and dirt. If necessary, use ethyl alcohol to clean the display panel. Perform the calibration procedure at least once every six months.

LUBRICATION

The only rotating parts of the wheel balancer are the motor and balance shaft. These parts must be periodically lubricated by the operators. If the machine is used very frequently, more than 2hours per day, we should annually check the bearing. And we will check once a year if the machine is used less than 2hours a day. When test, do not open up the bearing so you need insert a screwdriver to test the noise. Due to the function of the bearing is to clamp and support and not suitable to change or remove the grease. In addition, the speed of it is not too fast compared to the machine so no need to change the grease. If you note the run of the bearing abnormal or there is noise, change the bearing. If the customer confirms the bearing is not changed, you only need change the grease. Disassemble the bearing and open up the sealing ring and fill the XHP103 grease. These operation should be guided by the profession personnel and calibrate the machine after changing the grease. If the change of the grease not correctly, it will influence the accuracy of the machine. On this condition, you need to reinstall the sealing ring and assemble the machine and adjust again.

Technical safety card for using grease in the wheel balancer

Mobilgrease XHP

NLGI degree

cSt @ 40°C
Change of penetration 10 consistency, ASMT D 1831 (established upon the rolling of the greases), mm/10
4 spheres test, impression 0.5 diam., ASTM D 2266, mm

4 spheres test, welding load, ASTM D 2509, kg	315
Test Timken OK load, ASTM D 2509, lb	45
Stability of oxidization bomb method, ASTM D 942, pressure drop at 100 hours, kPa	35
Corrosion prevention, ASTM D 1743	Passed
Emcor rust, IP 220, wash away with acid water	0
Rust protection, IP 220-mod, wash away with distilled water	0
Corrosion on copper, ASTM D 4048	1A
Resistance to water spray, ASTM D 4049, % spray	15
Wash away with water, ASMT D 1264, loss (weight%), @ 79°C	5

SCRAPPING

If the machine is to be scrapped, separate all electrical, electronic, plastic and ferrous components and dispose of them separately, as provided for by local regulations in force.

ENVIRONMENT INFORMATION

If the machines have the crossed-out bin symbol



on their data plate  , the following disposal procedure must be applied to.

This product may contain substances that can be hazardous to the environment and to human health if it is not disposed of properly.

Electrical and electronic equipment must never be disposed of in the usual municipal waste but must be separately collected for their proper treatment.

The crossed-out bin symbol  , placed on the product and on this page, reminds the user that

the product must be disposed of properly at the end of its life.

Thus, the hazardous consequences that non-specific treatments of the substances contained in these products, or improper use of parts of them, may have on the environment or on human health are prevented. Furthermore, this helps to recover, recycle and reuse many of the materials contained in these products.

Electrical and electronic manufacturers and distributors set up proper collection and treatment systems for these products for this purpose.

Contact your local distributor to obtain information on the collection procedures at the end of the life of your product.

When purchasing this product, your distributor will also inform you of the possibility to return another end-of-life piece of equipment free of charge as long as it is of equivalent type and had the same functions as the purchased product.

Any disposal of the product performed in a different way from that described above will be liable to the penalties provided for by the national regulations in force in the country where the product is disposed of.

Further measures for environmental protection are recommended: recycling of the internal and external packaging of the product and proper disposal of used batteries (only if contained in the product).

Your help is crucial to reduce the amount of natural resources used for manufacturing electrical and electronic equipment, minimize the use of landfills for product disposal and improve the quality of life, preventing potentially hazardous substances from being released in the environment.

FIREFIGHTING MEANS TO BE USED

Consult the following table to choose the most suitable fire extinguisher.

Dry materials
 Water YES
 Foam YES
 Powder YES*
 CO2 YES*

YES* Use only if more appropriate extinguishers are not at hand or when the fire is small.

Flammable liquids

Water NO
 Foam YES
 Powder YES
 CO2 YES
 Electrical equipment
 Water NO
 Foam NO
 Powder YES
 CO2 YES



Warning

This table contains general instructions to be used as guidelines for users. All the applications of each type of extinguisher must be obtained from the relevant manufacturer.

9.DETAILED MACHINE

OPERATION:

9.1 How to balance a tire?

1. Switch on the power source
2. Select the cone according to the tire. Assemble the tire on the main shaft of the wheel balancer and firmly lock it.
3. Input the tire parameter.

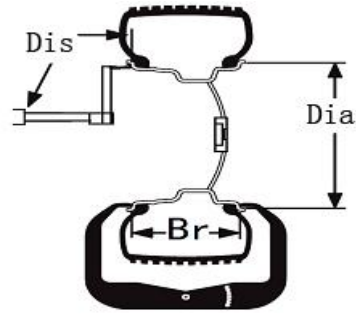

3.1 Pull out the scale of the balancer to measure the Di value which means the distance from the insides of the tire to the body. According to the measured reading, the unit of which is cm, press



Dis+ / ↑



Dis- / ↓

to adjust the value to make the value displayed in the right side window to be the measured value. But the unit of this displayed value is mm. eg you should input 55mm if the measured value is 5.5cm.

3.2 Use the width measurement scale to measure



Br+



Br-

the Br. you can press to input the Br value which is the implied value with the unit of inch. If you want to convert this value into the

value with the unit of mm, press to realize the conversion between the units.

3.3 Check the D value, which means the diameter of the rim, marked on the tire. Press



Dia+ / ↑



Dia- / ↓

key to adjust the value in the right window to be the diameter of the rim. You can also realize the conversion of the unit of the

Dia to be mm by the key.

4. Lower down the protective cover (you can also press the start key). After the machine starts, rotate and test, it will automatically stop. In the left /right window, the corresponding values will be displayed. Rotate the tire, when all the positions

indication lamps light. Pls add the weight corresponding to the value displayed in the window. Once again, start the machine to test. The window will display the unbalance value. The balance process will be completed until reaching the balance range you required.



9.2 MACHINE PARAMETER SETUP





Press  to enter program setup menu.

1.1 -p-(hood setup) press  to confirm the



entrance select   to setup the on/off of the function of the hood. Press  to confirm.

1.2 -SP-(hood control function setup). In the upper condition, press . The display will display as the left figure.

Press  to confirm the entrance.







function. Press  to confirm after confirmation.



1.3 APP(minimum unbalance setup), In the upper state, press  to enter the APP setup.

Press  to enter the setup



Select the corresponding unit. Press  key to

confirm the entrance, Select   to select the unbalance unit is 1Gr or 5Gr. Press  key to confirm.



BIP (beeper setup) Press  to setup the on/off of the deeper.

Press  to confirm the entrance. Select

  to setup the on/off of the beeper. Press  to confirm.

Press  to enter the sub-level



- 1 "SET"—"UP" Press  to enter the special function setup program
- 2 option: "IP"—"TES" and "CAL"—"CAL"



Select  to display in cycle.

In the condition of "IP"—"TES", press  to enter the condition of test.

In the condition of POS, rotate the tire clockwise, the value in the right window will increase. Counterclockwise, decrease.



Press  key to test static sensor

In the condition of STA, press the pizeo sensor perpendicular to the main shaft, the value in the right window will change which means the

installation of the sensor is correct



Press  key to test static sensor

In the condition of DYN, press the pizeo sensor

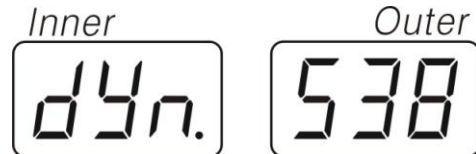

9.3 CUSTOMER SELF-CALIBRATION

In the condition of IP-TES, select  to enter CAL-CAL, means customer self-calibration state. We use this when the machine has not been used for a long time or the balancing is inaccurate.



Press  to enter into the program.

This function can be used after inputting tire parameter.

***hold on pressing  for 5seconds to enter this state.**

Press  to enter and the display will display "ADD"—"0"



Press  to span the machine.

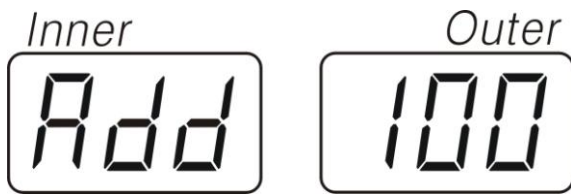

The window will display "ADD"-"100", then Use your hand to rotate the tire until all the right side lamp light up. At this moment clip the weight of 100g at the 12 clock

position outside of the tire. Press  to span the machine. Until the span is over, you finish the self-calibration of the machine.

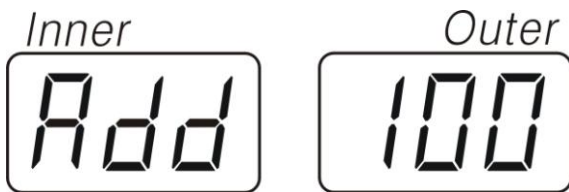



After complete the customer self-calibration, it will display "SAV"-"DAT". Then the customer self-calibration is finished.









Factory Self-Calibration:

If the customer self-calibration will not be helping to maintain the machine to have satisfactory balancing stability, we recommend that you proceed Factory Self-Calibration procedure. Below you would find the detailed instruction:

Press “Home button” one time , and it displays “[P]”, press “DIS + button” one time  , and you will see “[SET]-[UP]”

Press “Home button” two times , and it displays [POS--XXX], pull the wheel by hand(clock-wise or anti-clock-wise) slowly.

When it displays [POS]—[110] press ‘Fine button’ one time , then continue to pull the wheel slowly until it displays [POS]—[120] Press “ Fine button” one time .

The screen displays[ADD]-[0], press  to start rotation of the machine.

When machine stops rotation, it displays[ADD]—[100], at this moment, please pull the wheel until the outer indicating lights are all illuminating, clamp 100g calibration standard weight on the outside rim at 12

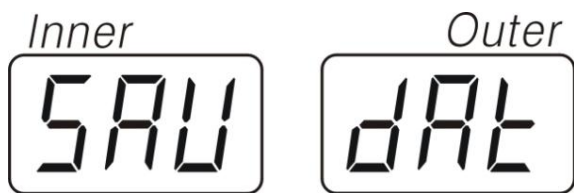

o'clock position. Press  to start rotation of the machine .

When the machine stops, it displays “100—ADD “, at this moment please remove that 100g standard weight from the outside rim edge firstly, then pull the wheel by hand until the inner indicating lights are all illuminating, clamp that 100g standard weight on the inside rim at 12

o'clock position, Press  to start the rotation again.

When it stops, you will hear 3 times beeps indication and the Factory Self-Calibration is over.

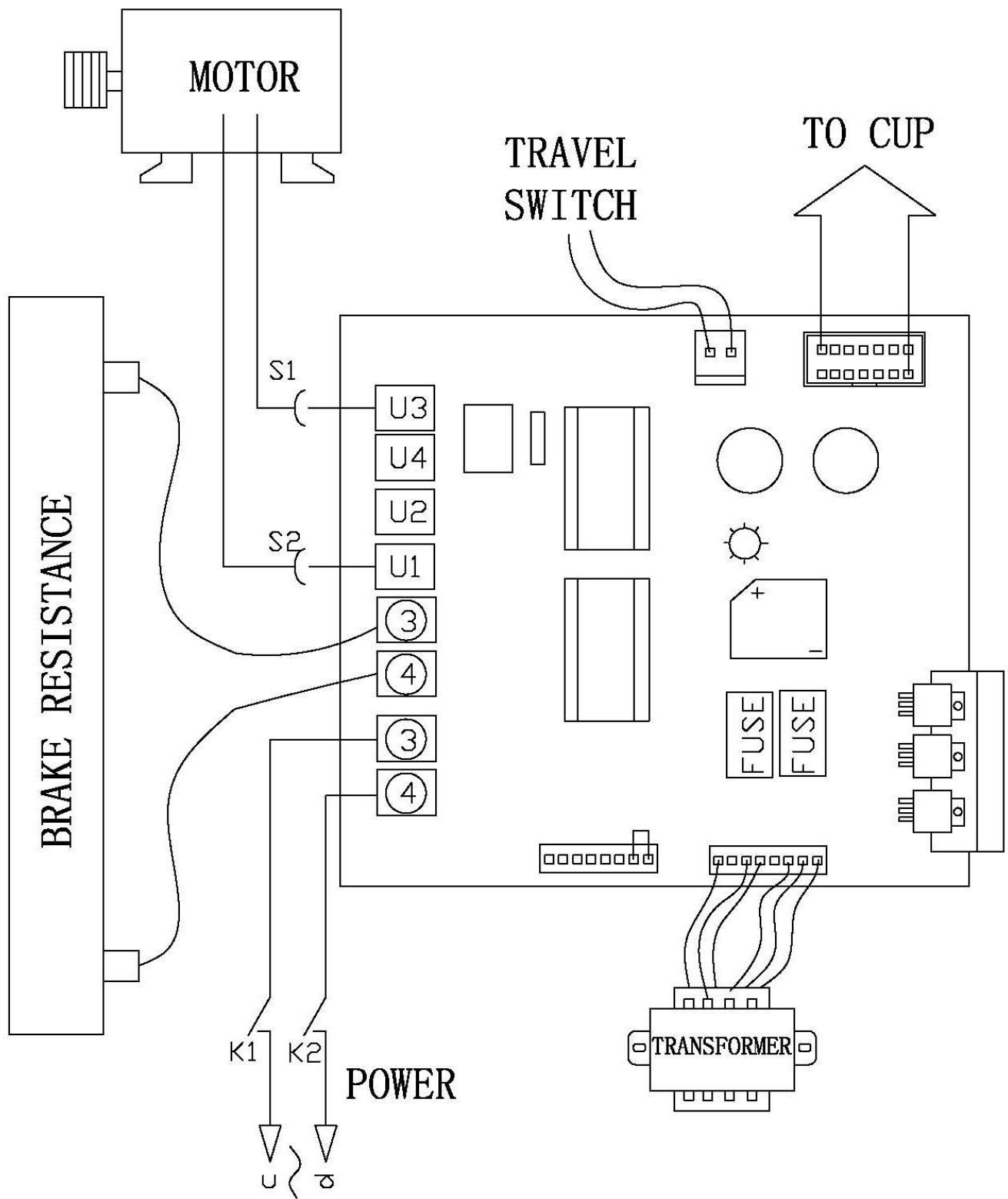

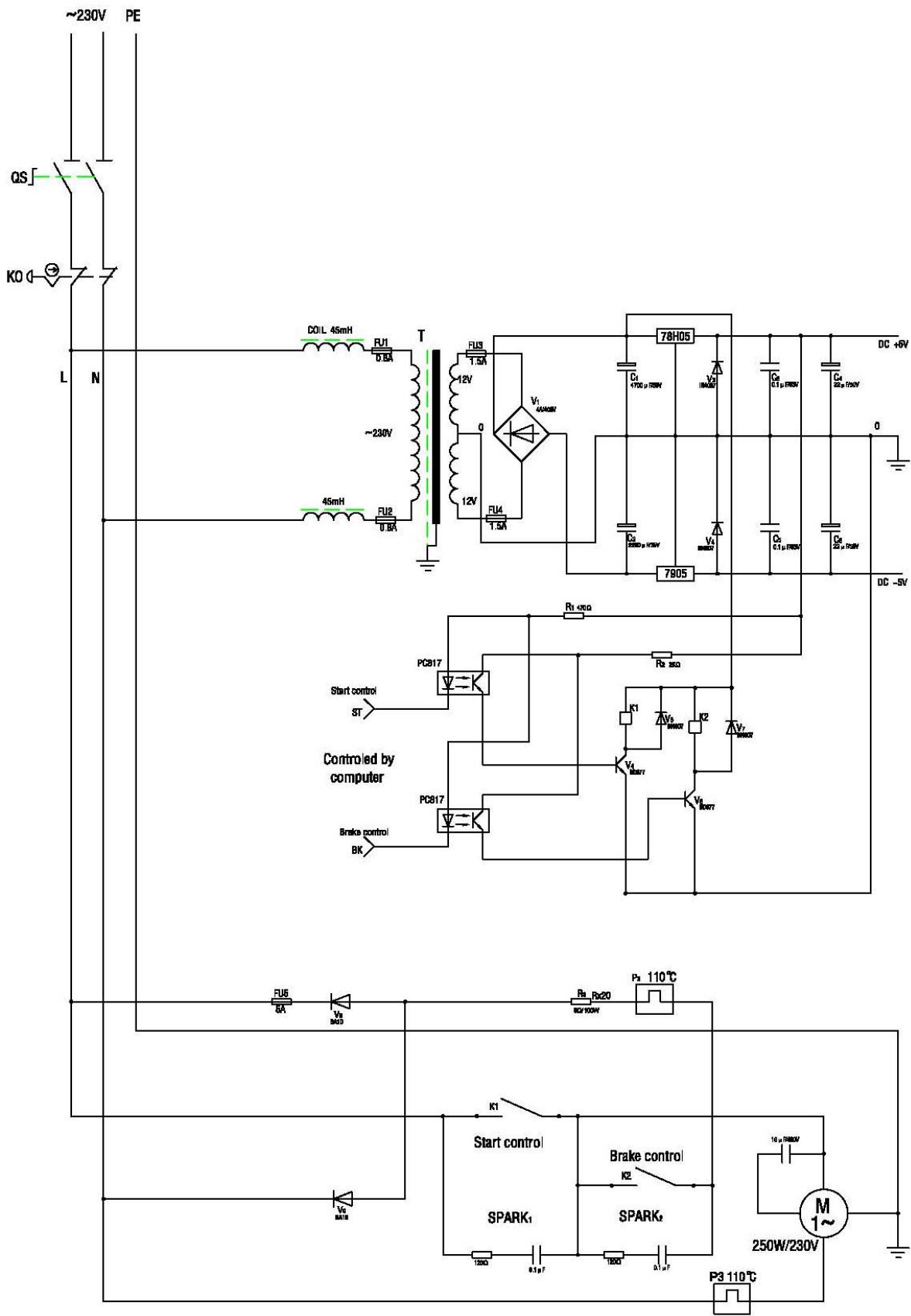

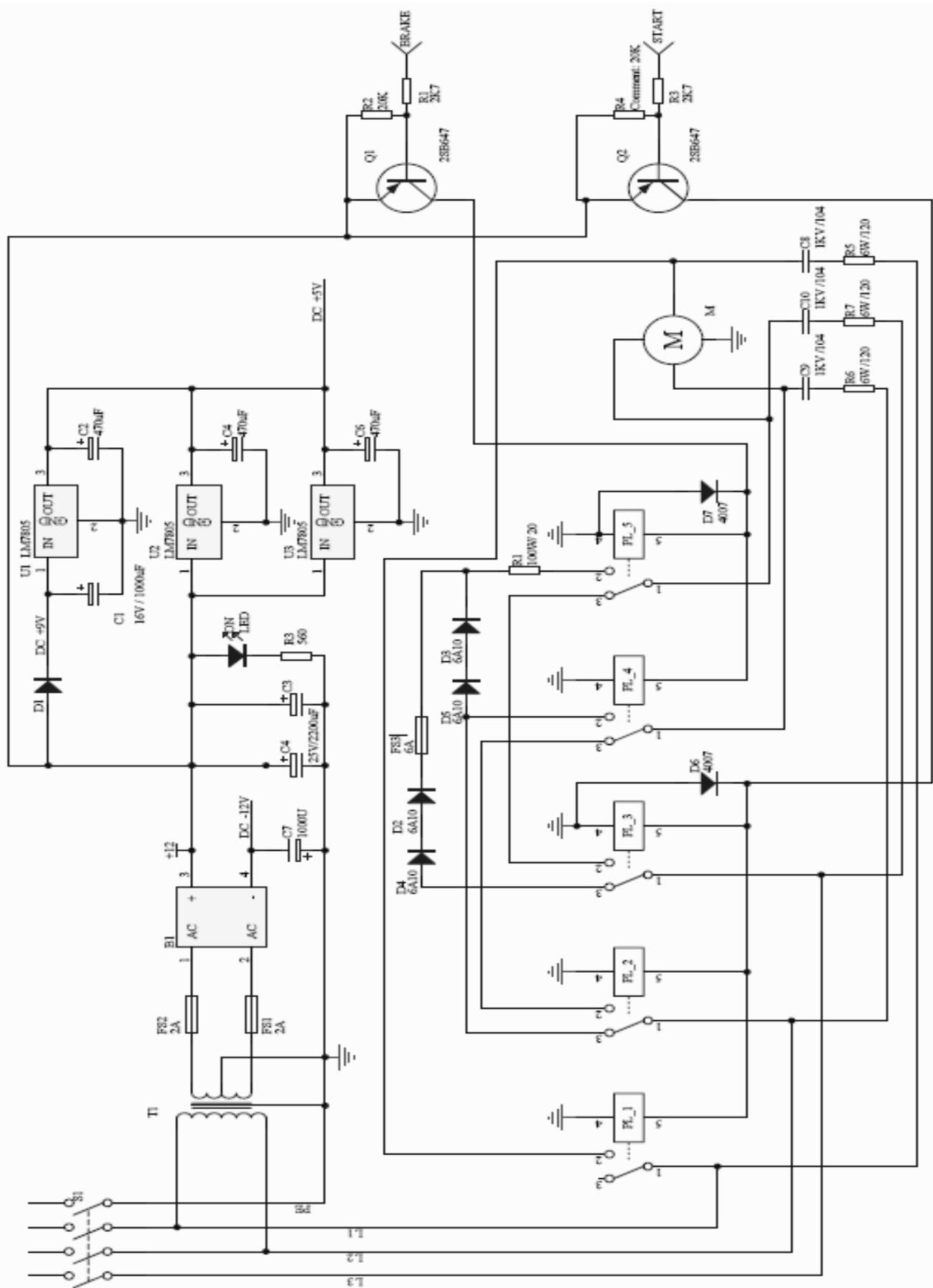

Appendix

Protective cover installation I

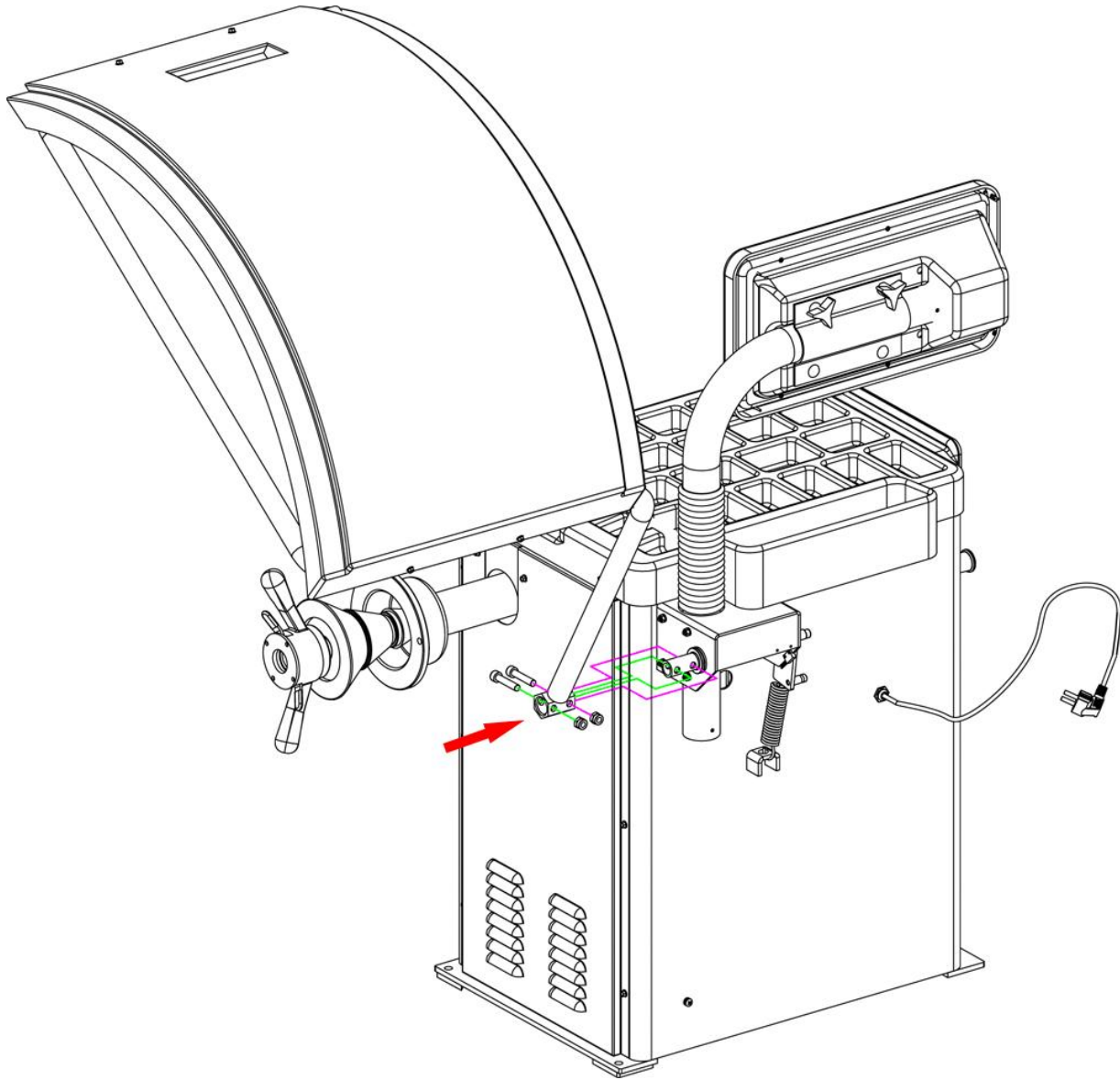

Appendix

Protective cover installation II

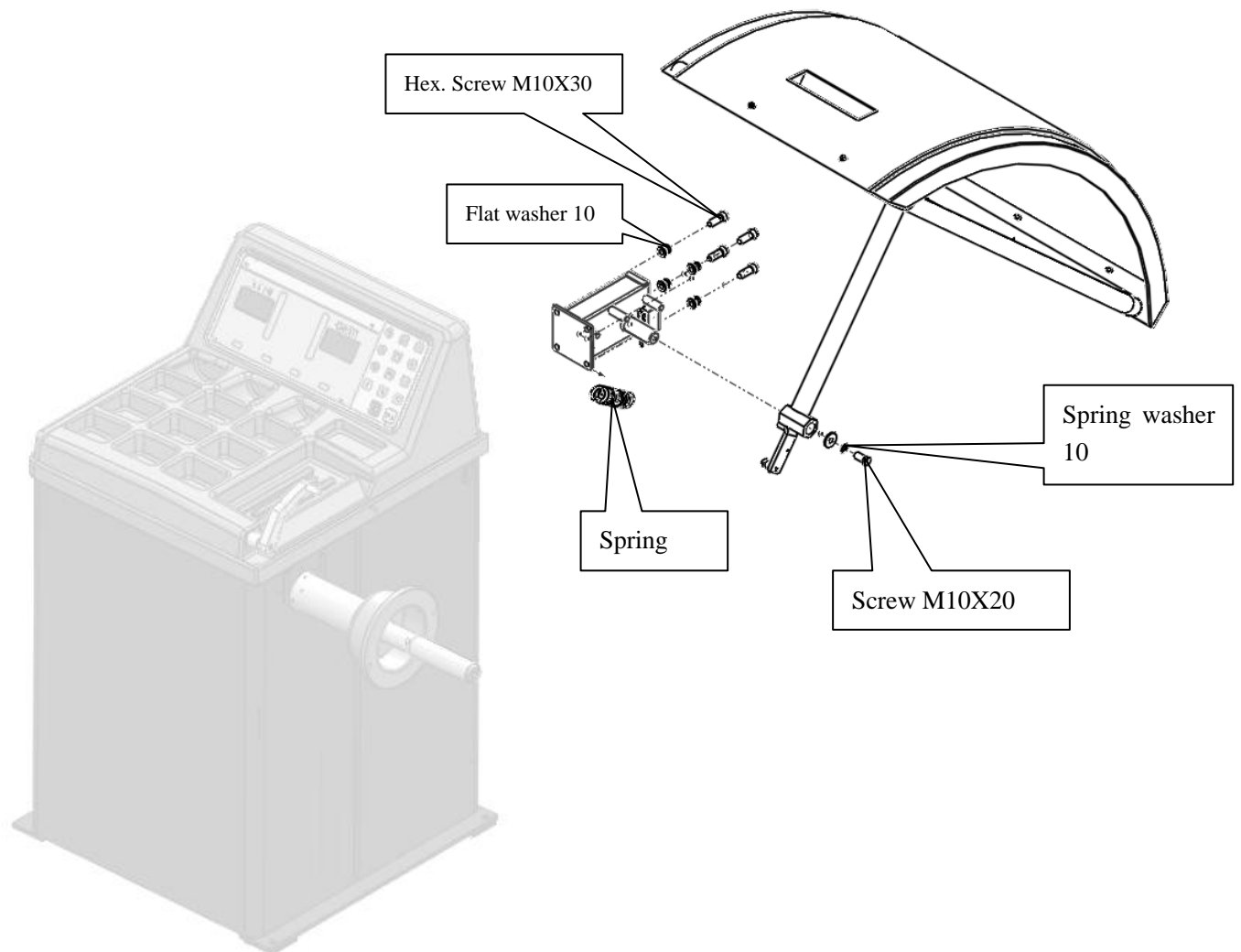

The manufacturer has the right to modify the products without notification to the buyer in advance